

Montageanleitung • Montážní návod • Fitting instructions • Instructions de montage

Technische Änderungen vorbehalten • Technická změna vyhrazena • Subject to technical alterations • Sous réserves de modifications techniques

Lieferumfang • Obsah balení
The pack contains • Fournitures

(A) 1 x

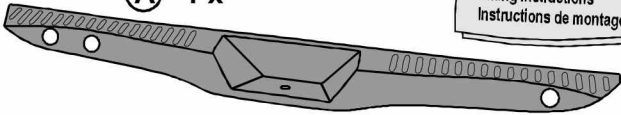

(B) 1 x

Montageanleitung
Montážní návod
Fitting instructions
Instructions de montage

Gerät • Nářadí • Tools • Outils

TORX 40

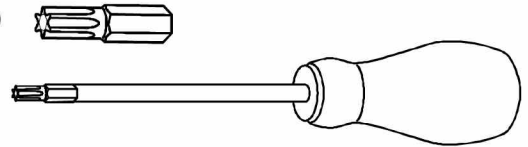

1.

1 x original
TORX 40

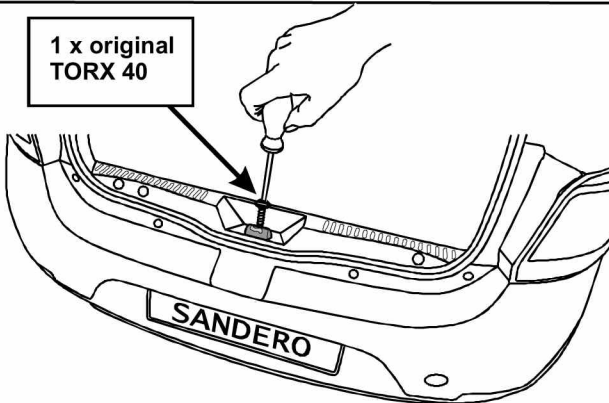

2.

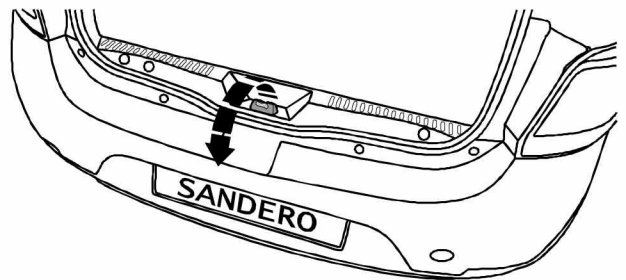

3.

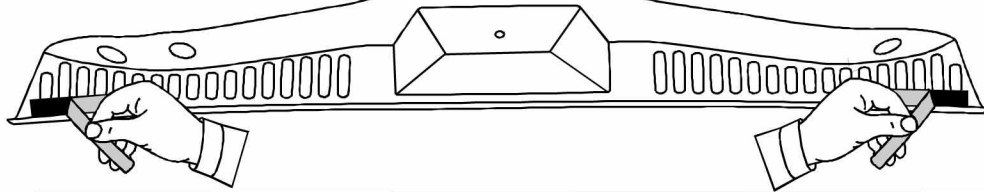

4.

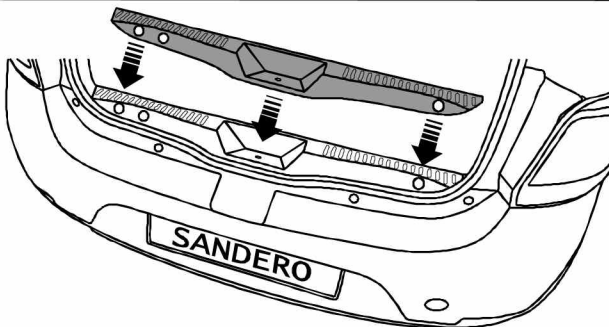

5.

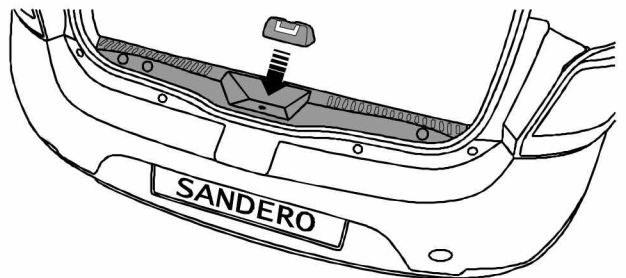

6.

1 x original
TORX 40

drücken
přitlačit
press
presser

drücken
přitlačit
press
presser

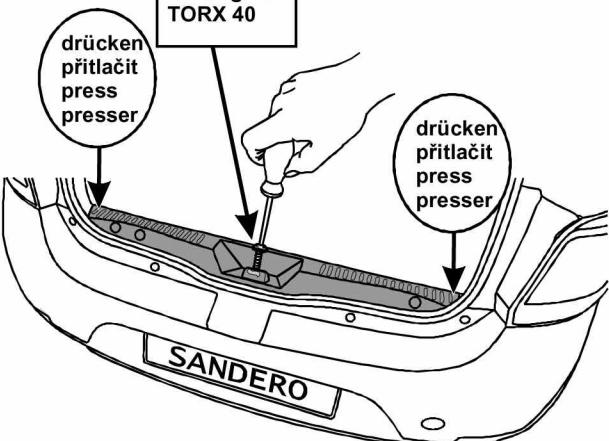

7.

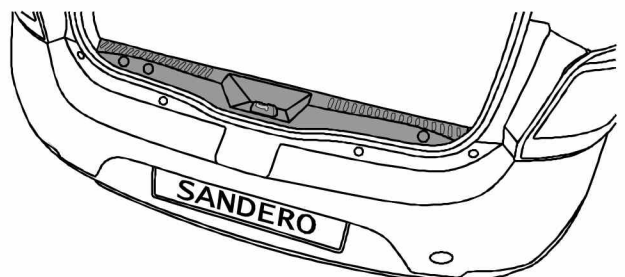

OK ✓